





## Broadband High Power Amplifier Module (SSPA)

### 20-520MHz/100Watt/Module

Model Number: MCW002052M50A

The model MCW002052M50A is a high power amplifier operating between 20MHz and 520MHz and offering a wide dynamic Range with 100 Watts typical saturated power. The employment of LDMOS and chip-and-wire technology in manufacturing ensures this module state-of-the-art power performance with excellent power-to-volume ratio. It is ideal for jamming, EMC, test and measurement applications.

#### FEATURES:

-  Small Size and Light Weight
-  Instantaneous Ultra-broadband
-  50 Ohms Input and Output Matched
-  Built-In Control and Protection Circuits
-  Class AB

#### ELECTRICAL SPECIFICATIONS @ +28.0VDC, 25°C, 50Ω

Parameter	Symbol	Minimu	Typ	Maximum	Units
Operating Frequency	BW	20		520	MHz
RF Output Power	P <sub>out</sub>		100		Watt
Power Gain	G		50		dB
Small Signal Gain Flatness	Δ G <sub>SS</sub>		±2		dB
Input Return Loss	S <sub>11</sub>			-10	dB
Harmonics @50W	H		-10		dBc
Spurious Signals	Spur		-60		dBc
In/Output Impedance			50		Ω
Operating Voltage	V <sub>DC</sub>	24	28	32	Volt
DC Current @100W	I <sub>DD</sub>		9		Amp

#### MECHANICAL SPECIFICATIONS

Parameter	Value	Units	Limits
Dimensions	150x90x25 [5.91x3.54x0.98]	mm [inch]	Maximum
Weight	1.2 [2.6]	kg [lbs]	Maximum
RF Connectors Input	SMA, Female		
RF Connectors Output	SMA, Female		
DC Interface Connector	D-Sub 9-Pin, Male		
Cooling	External Heatsink (Not Supplied)		

#### ENVIRONMENTAL CHARACTERISTICS (Design to Meet)

Parameter	Minimum	Typical	Maximum	Units	Notes
Operating Temperature	-20		60	°C	
Non-operating Temperature	-25		65	°C	Storage
Relative Humidity (non-condensing)			95	%	

#### Absolute Maximum Rating

Input RF drive level without damage	+10 dBm	Maximum
Load VSWR @ P <sub>OUT</sub> =50W	∞ @ all load phase & amplitude for duration of 1 minute; 3:1 @ all load phase & amplitude continuous	
Thermal Overload	85°C ±5°C shutdown	Maximum

\*Chengdu Microwave Technology Co., Ltd\*

>>1st Floor, Building 3#, Huidu Science Park, No.5 Xixin Avenue, High-tech West District, Chengdu, China 611731

>>Tel:+86(28)87872669\*0

>>Fax:+86(28)87882925

>>Mobile/WhatsApp:+86-181 8078 9271

>>Email: [info@cdmicrowave.com](mailto:info@cdmicrowave.com)

>>[www.cdmicrowave.com](http://www.cdmicrowave.com)

**Broadband High Power Amplifier Module (SSPA)**

**20-520MHz/100Watt/Module**

Model Number: MCW002052M50A

**DC INTERFACE CONNECTOR**

Pin #	Description	Specifications
1	ENABLE	Amplifier ENABLE: TTL Logic High (3.3V) (Internally Pulled-Low)
2	TEMP MONITOR	Analog voltage relative to Module's Temperature @ 10 mV/°C
3	CURRENT MONITOR	Analog voltage relative to IDD @ 100 mV per Ampere
4	VDD	28VDC
5	VDD	28VDC
6	GND	Ground
7	GND	Ground
8	GND	Ground
9	VDD	28VDC

**Functional Diagram**

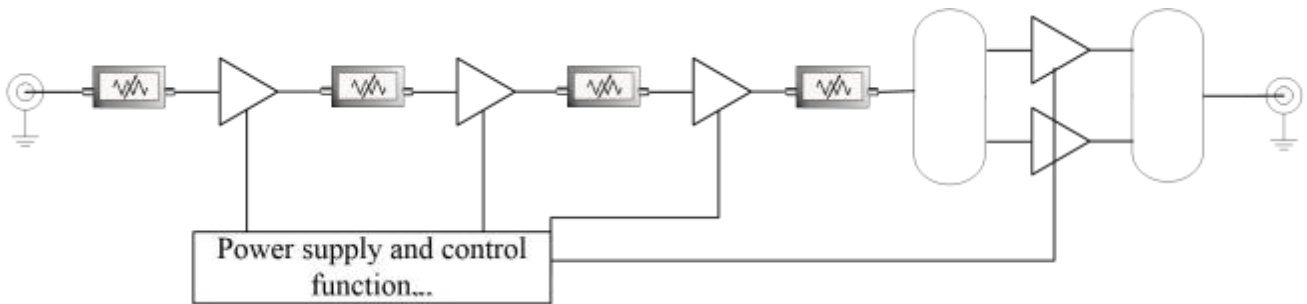

**OUTLINE DRAWING (All dimensions in mm [inch])**

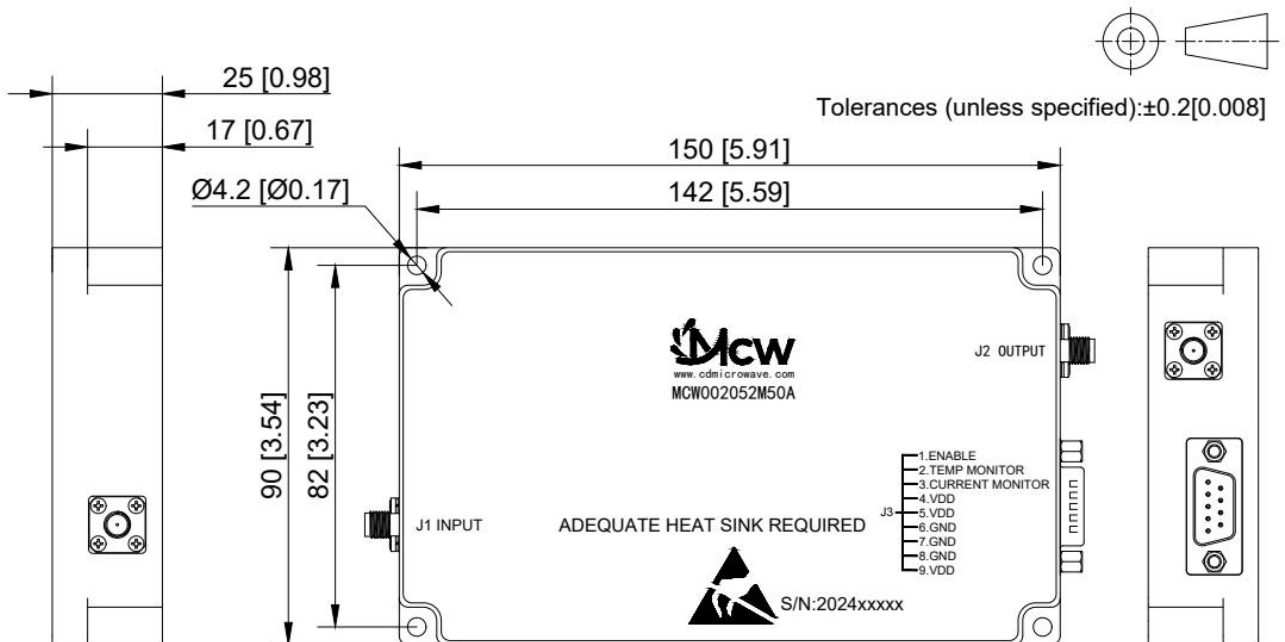

## 20-520MHz/100Watt/Module

Model Number: MCW002052M50A

TYPICAL PERFORMANCE PLOTS (for reference)

Graph1: Output Power (Low temp.-20±3°C)

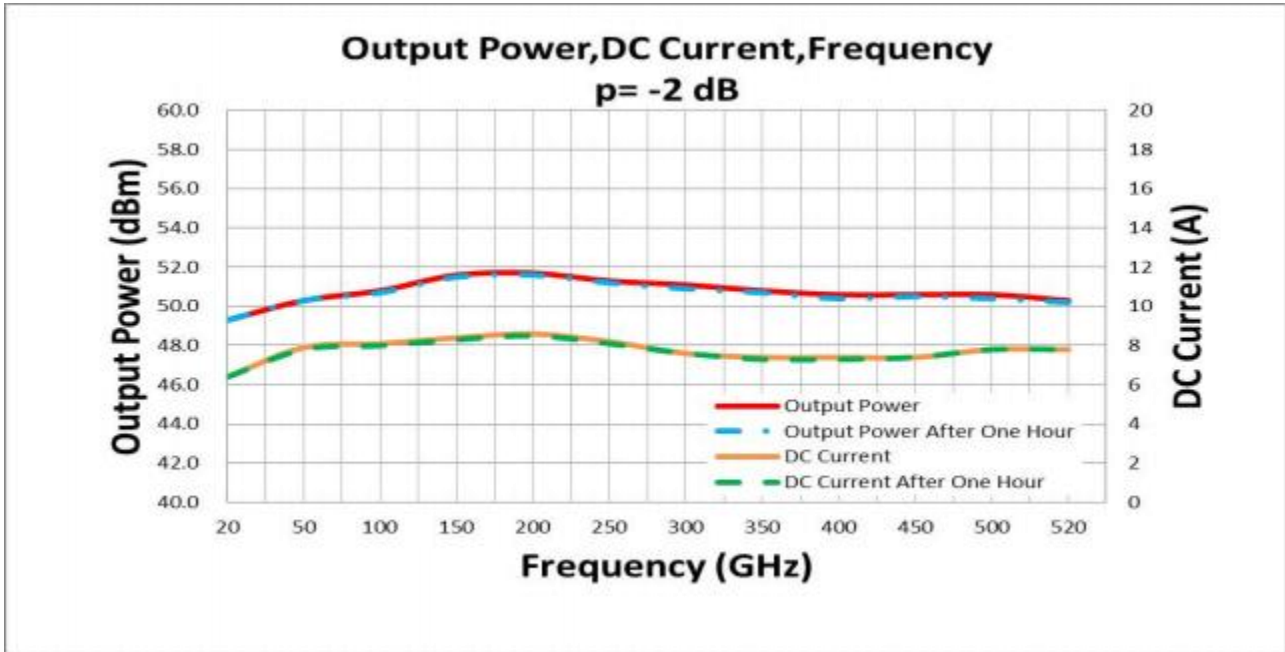

Graph2: Output Power (High temp.+60±3°C)

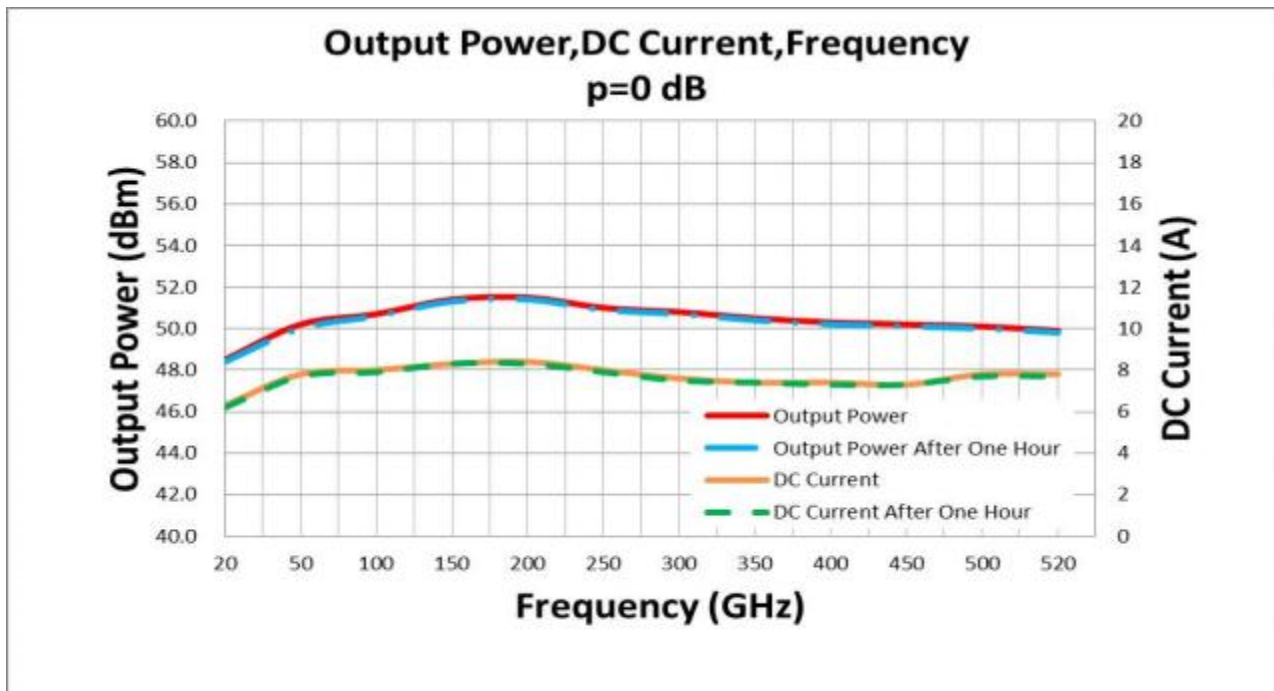

## 20-520MHz/100Watt/Module

Graph3: Output Power (Normal temp.+25±3℃)

Model Number: MCW002052M50A

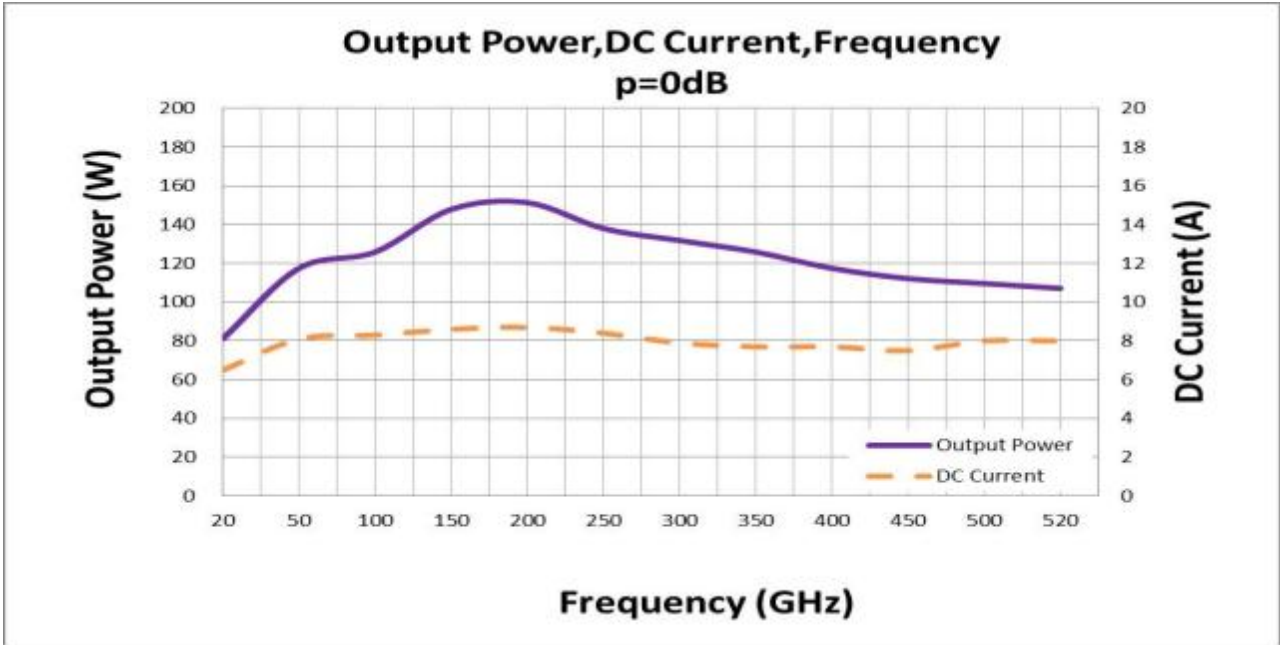

Power Gain:



\*Chengdu Microwave Technology Co., Ltd\*

>>1st Floor, Building 3#, Huidu Science Park, No.5 Xixin Avenue, High-tech West District, Chengdu, China 611731

>>Tel:+86(28)87872669\*0

>>Fax:+86(28)87882925

>>Email: [info@cdmicrowave.com](mailto:info@cdmicrowave.com)

>>Mobile/WhatsApp:+86-181 8078 9271

>>[www.cdmicrowave.com](http://www.cdmicrowave.com)

## 20-520MHz/100Watt/Module

Model Number: MCW002052M50A

Input Return Loss:



### Important Note:

1. Adequate heatsink required.
2. This product will be developed upon contract/order. All the above specs are for reference only. Actual product may be different. Please check with [Chengdu Microwave Technology Co., Ltd](http://Chengdu Microwave Technology Co., Ltd) sales team or E-mail to [info@cdmicrowave.com](mailto:info@cdmicrowave.com) if you have any more questions.

*\*Chengdu Microwave Technology Co., Ltd\**

>> 1st Floor, Building 3#, Huidu Science Park, No.5 Xixin Avenue, High-tech West District, Chengdu, China 611731

>> Tel: +86(28)87872669\*0

>> Fax: +86(28)87882925

>> Mobile/WhatsApp: +86-181 8078 9271

>> Email: [info@cdmicrowave.com](mailto:info@cdmicrowave.com)

>> [www.cdmicrowave.com](http://www.cdmicrowave.com)