

MCW9k20GSG

9kHz-20GHz Signal Generator



Chengdu Microwave Technology Co., Ltd



PRODUCT OVERVIEW

Chengdu Microwave MCW9k20GSG series product is our miniaturized signal generators featured with high cost-effectiveness. Frequency ranges from 9kHz to 20GHz, dynamic output power extended from -120dBm to 17dBm. This state of art series of signal generator is excellent for its high spurious, low phase noise, wonderful signal purity and signal stability. Therefore, MCW9k20GSG is capable to be applied to the Test & Measurement in the harsh environment of Semiconductor, Quantum Technology, Radar and Communication.



BLOCK DIAGRAM

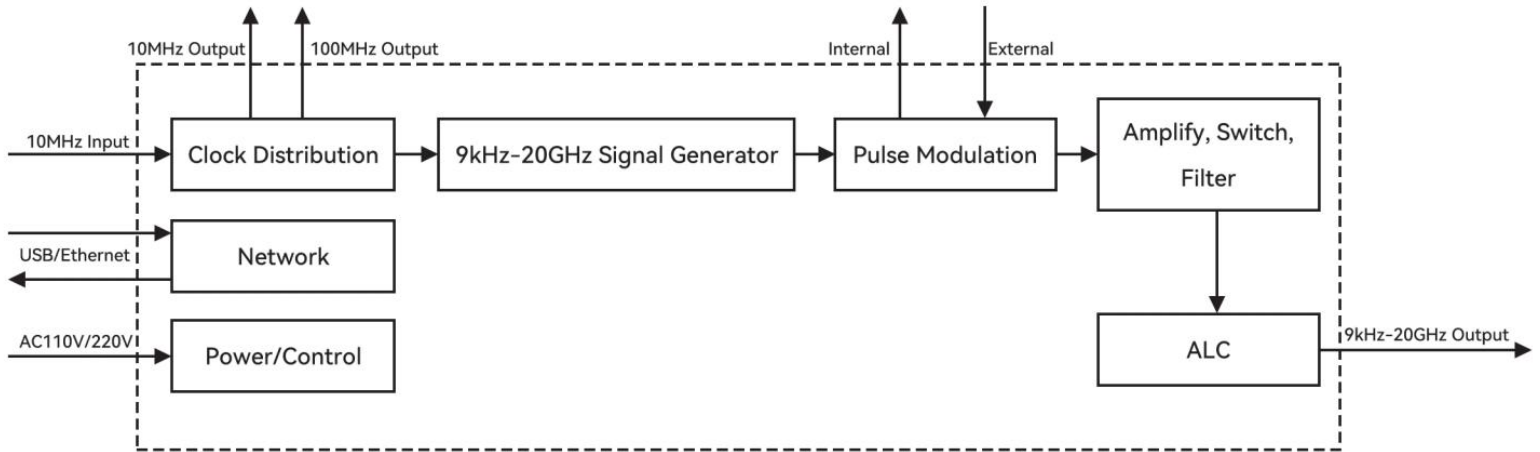

PERFORMANCE

Frequency Range

9kHz~20GHz

Frequency Resolution

0.001Hz

Output Power

-120dBm~+17dBm

Amplitude Resolution

0.1dB

Spurious

-80dBc@10GHz

Harmonics

-50dBc@10GHz

Phase Noise

-112dBc/Hz@10kHz(10GHz)

Dimensions

360mm×360mm×89mm

PRODUCT FEATURE

- I Cost Effectiveness
- I Compact Size
- I Low Spurious
- I Low Harmonics
- I Low Phase Noise
- I High Dynamic Output Power



ELECTRICAL SPECIFICATIONS

Parameter	Min.	Typ.	Max.	Note
Frequency Range	9kHz		20GHz	
Frequency Resolution		0.001Hz		
Operating Mode	CW/Sweep			
Frequency Reference				
Internal Reference Aging Rate	±0.3ppm/year			
Initial Calibration Accuracy		±0.1ppm		
External Reference (500)				
Input Frequency		10MHz		
Input Power	+3dBm	+5dBm	+10dBm	
Lock Range		±0.5ppm		
Wave	Sine /Square			
Internal Reference				
Output Frequency	10MHz, 100MHz			
Output Power	+5dBm		+10dBm	Output Freq.:10MHz
	+5dBm		+10dBm	Output Freq.:100MHz
Output Frequency Stability	±0.1ppm			
SSB Phase Noise		-145dBc/Hz@1kHz		Output Freq.:10MHz
		-155dBc/Hz@1kHz		Output Freq.:100MHz
Spurious	-70dBc			
Switching Speed				
Sweep	10ms			
Pulse		50ns		≥100MHz
		120ns		<100MHz
Output Power				
1GHz	-120dBm		+17dBm	
10GHz	-120dBm		+17dBm	
20GHz	-120dBm		+17dBm	
Output Power Resolution	0.1dB			
Impedance		500		

Parameter	Min.	Typ.	Max.	Note
Harmonics				
1GHz		-50dBc	-40dBc	
10GHz		-55dBc	-40dBc	
20GHz		-45dBc	-40dBc	
1/2 Harmonics				
1GHz		-90dBc	-80dBc	
10GHz		-90dBc	-80dBc	
20GHz		-85dBc	-80dBc	
Spurious (Frequency Offset ≥ 5kHz)				
1GHz		-85dBc	-80dBc	
10GHz		-80dBc	-75dBc	
20GHz		-74dBc	-70dBc	
Pulse Modulation				
On/Off Ratio		-65dBc		
Min. Pulse Width		100ns		
Min. Period		110ns		
External Pulse Input				
LVTTL		+3.3V		
Internal Pulse Generator				
Square Wave Speed Rate	0.1Hz		10MHz	
Period	110ns		100s	
Pulse Width	100ns		99.999999s	
Rise Time		25ns		>100MHz
Fall Time		25ns		>100MHz
Resolution		100ns		
Delay	20ns		100s	
Sweep				
Operating Mode		Step Sweep		
Sweep Range	9kHz		20GHz	
Dwell Time	10ms		10s	
Time Resolution		1 μ s		
Switching Speed		300 μ s		Internal Source
General Specifications				
Control				Keyboard, Touchscreen, SCPI
Power Requirements	AC110V		AC240V	
Operating Temperature	0°C		+50°C	
Weight			10kg	
Dimensions		360mm \times 360mm \times 89mm		Corner Pad Not Included

SSB Phase Noise

Parameters	100Hz	1kHz	10kHz	100kHz	1MHz
dBc/Hz@1GHz	-104	-132	-131	-130	-134
dBc/Hz@10GHz	-84	-109	-112	-111	-115
dBc/Hz@20GHz	-79	-100	-106	-105	-109

Absolute Level Accuracy

Parameters	0dBm<Pout	-20dBm<Pouts0dBm	-70dBm<Pouts-20dBm	-70dBm2Pout
9kHz<F≤1GHz	≤±0.5	≤±1.0	≤±2.0	≤±2.0
1GHz<F≤10GHz	≤±0.5	≤±1.0	≤±2.0	≤±2.0
10GHz<F≤20GHz	≤±1.0	≤±1.0	≤±2.0	≤±3.0

TYPICAL TEST CURVE

Output Power

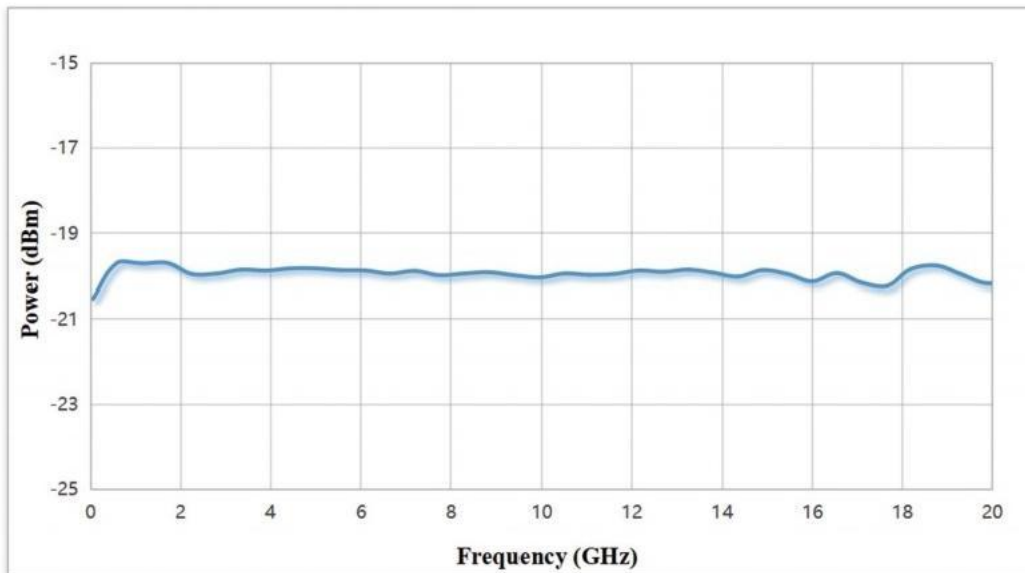

Output Power:-20dBm

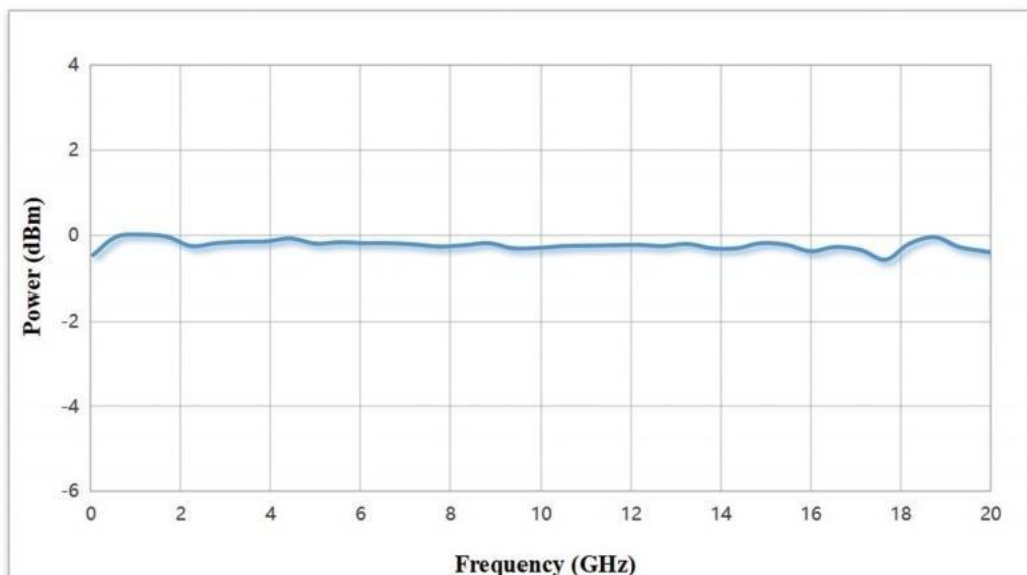

Output Power:0dBm

Output Power

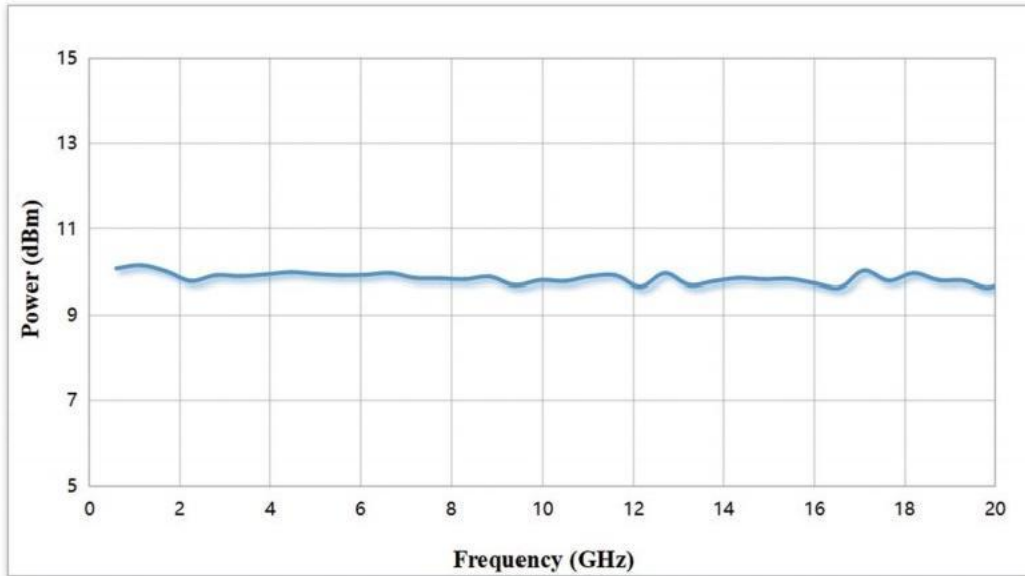

Output Power:+10dBm

SSB Phase Noise



Output Frequency:5GHz

SSB Phase Noise



Output Frequency:10GHz



Output Frequency:20GHz

Spurious

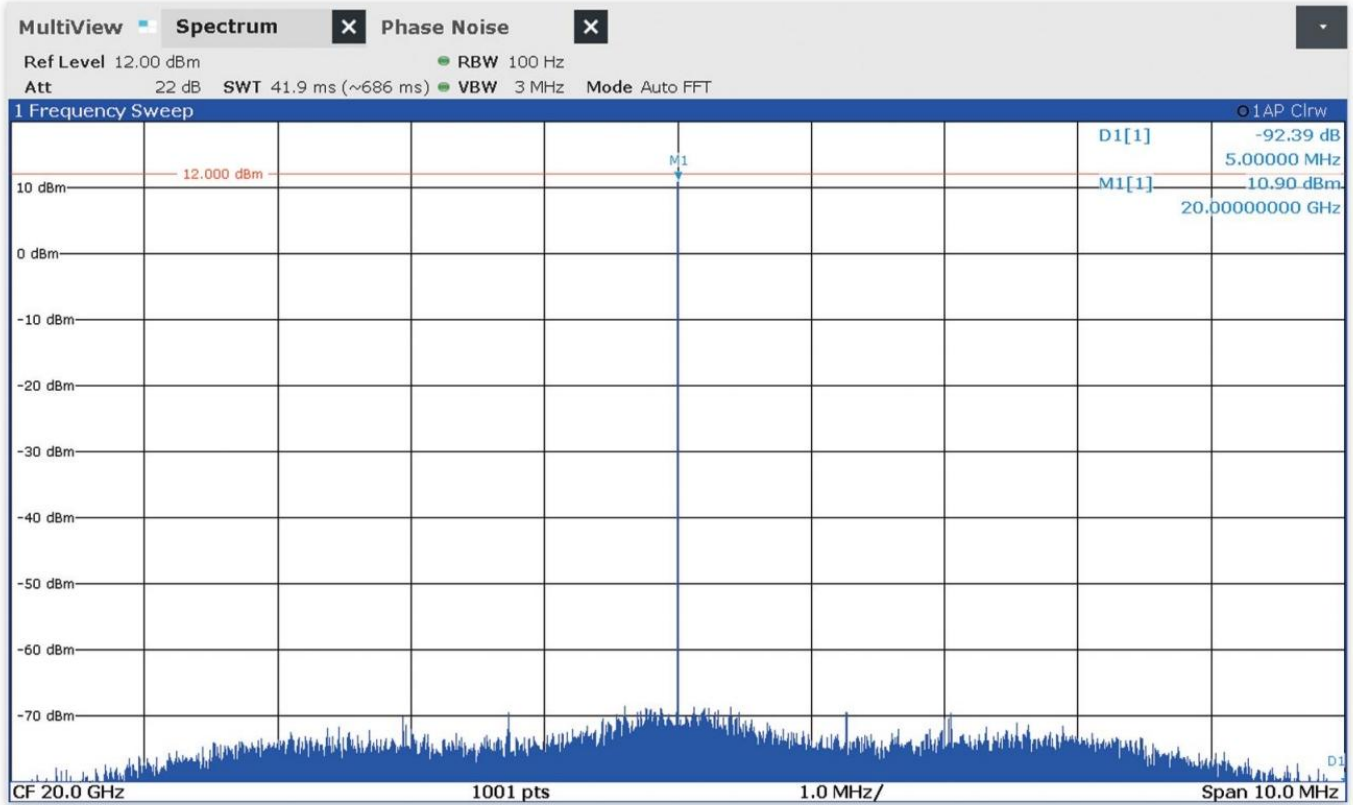

Output Frequency:20GHz

Harmonics

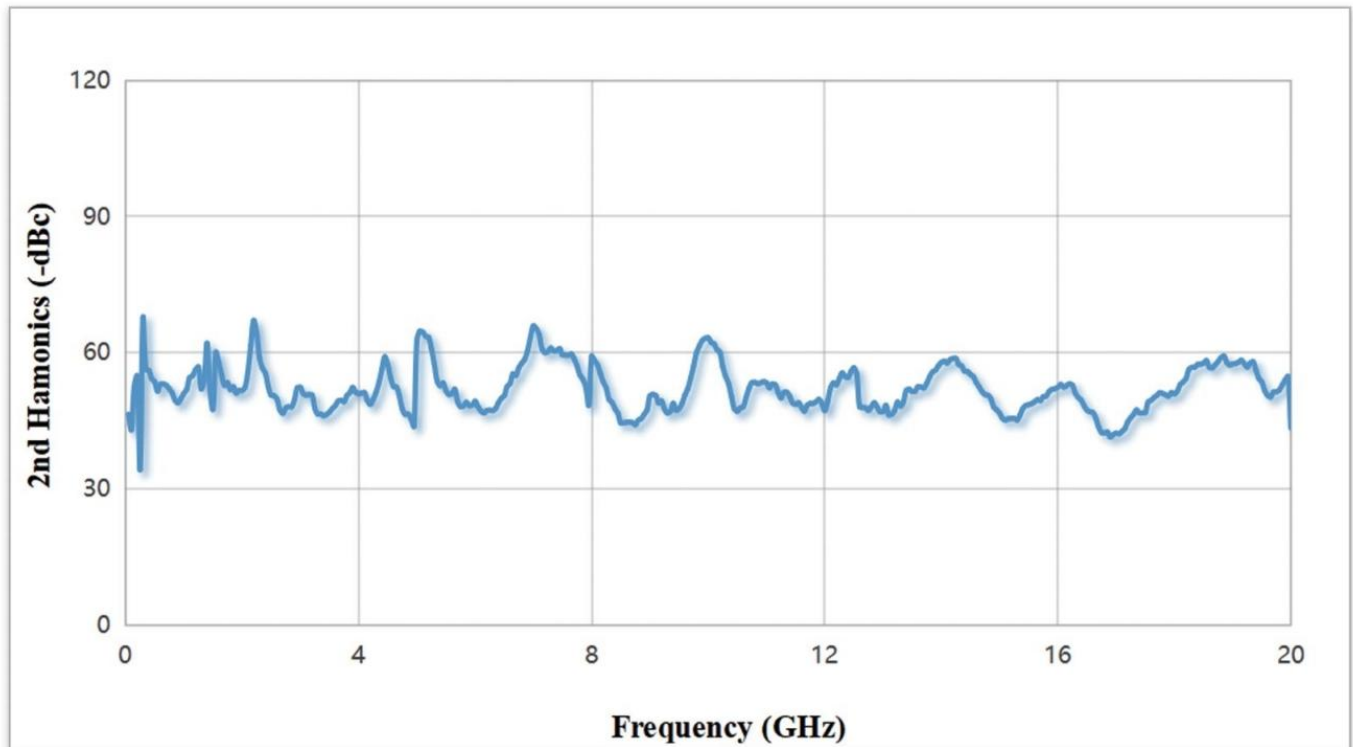

Output Power:+10dBm

Harmonics

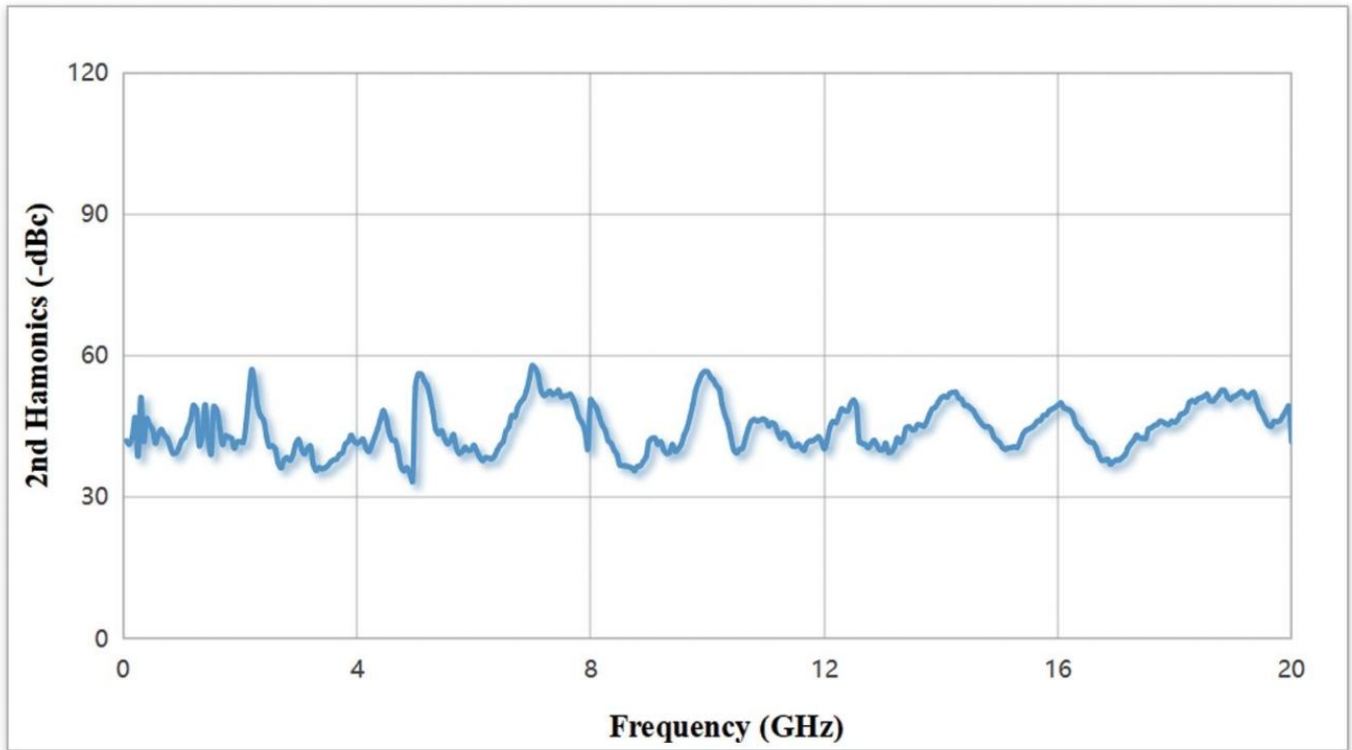

Output Power:+17dBm

1/2 Harmonics

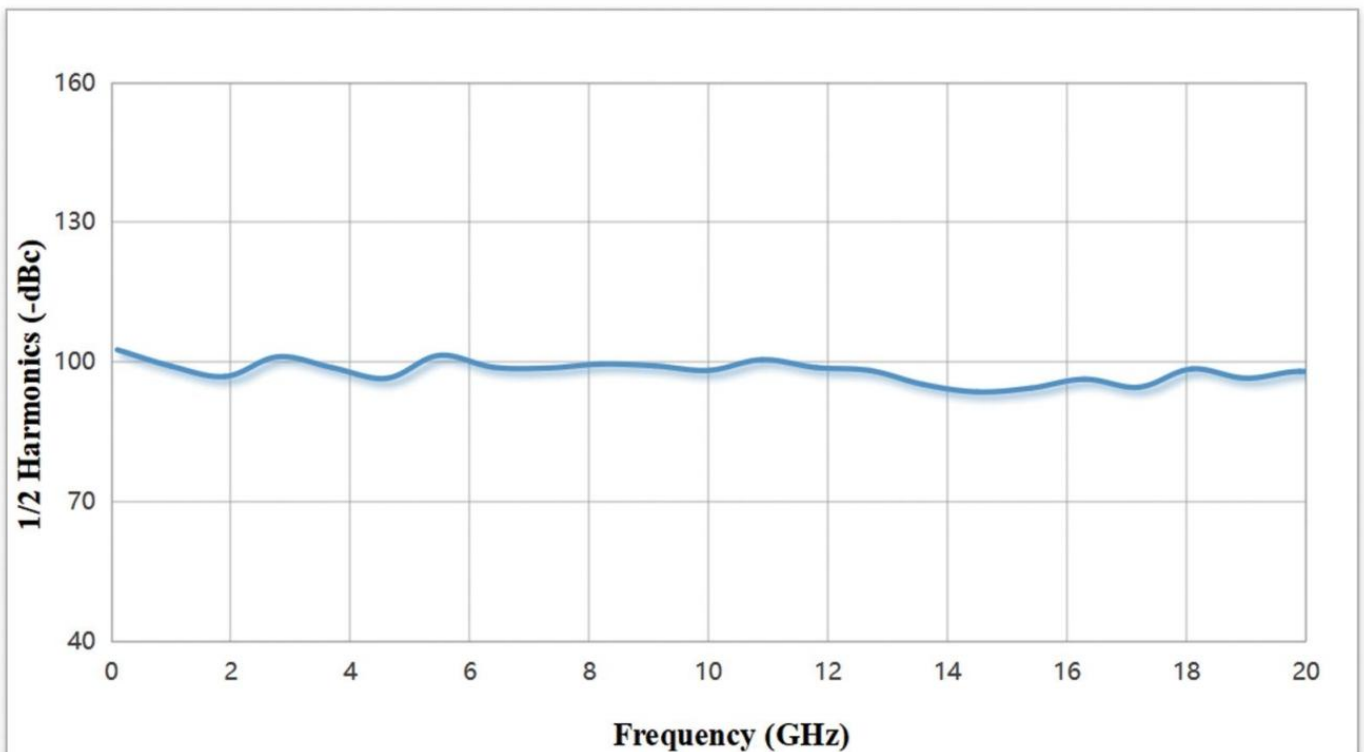

Attenuation Accuracy

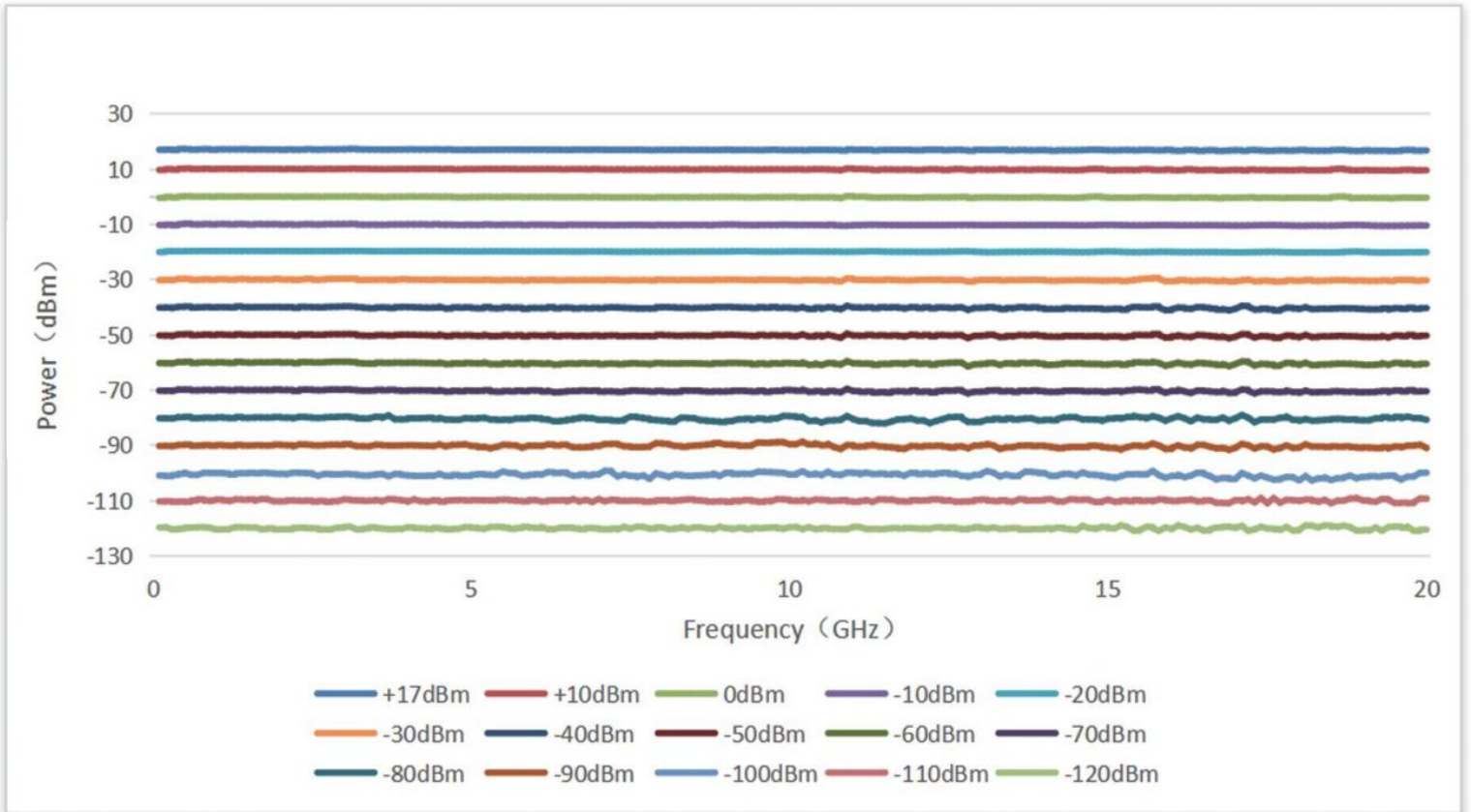

PRODUCT INTERFACE

Front

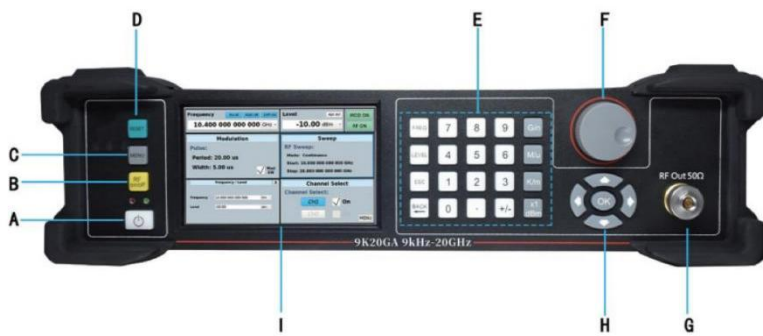

Ref.	Function	Description
A	DC ON/OFF	
B	RF ON/OFF	
C	Menu	
D	Reset	
E	Keyboard	
F	Knob	
G	RF Output	2.92mm-Male
H	Direction Key	
Screen		5.0inch

Back

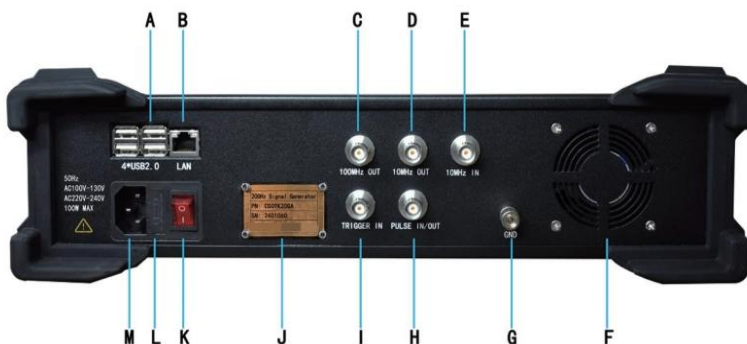

Ref.	Function	Description
A	USBPorts	4×USB2.0
B	Ethernet Port	RJ45
C	100MHz Output	BNC-Female
D	10MHz Output	BNC-Female
E	10MHz Input	BNC-Female
F	Fan	Exhaust
G	GND Terminal	GND
H	Pulse Signal Input/Output	BNC-Female
Trigger Signal In		BNC-Female
J	Name Plate	
K	AC ON/OFF	
L	Fuse Holder	Replaceable
M	AC Power Port	AC110-240V

SCREEN

Frequency PULSE MOD ON SWP ON		Level REF INT MOD ON	
10.400 000 000 000 GHz		-10.00 dBm	
Modulation		Sweep	
Pulse: Period: 20.00 us Width: 5.00 us		RF Sweep: Mode: Continuous Start: 10.000 000 000 000 GHz Stop: 20.000 000 000 000 GHz	
Frequency / Level X		Channel Select	
Frequency: 10.000 000 000 000 GHz Level: -10.00 dBm		Channel Select: CH1 <input checked="" type="checkbox"/> On CH2 <input type="checkbox"/> On	
		MENU	

Sweep		X
Sweep State	Off	
Sweep Mode	Single	
Start Freq.	10.000 000 000 000	GHz
Stop Freq.	20.000 000 000 000	GHz
Freq. Step	0.100 000 000 000	GHz
Dwell Time	10	ms
Sweep Time	1 010	ms

Options

Model/PN	Description
MCW9k20GSG	9kHz-20GHz Single Channel Signal Generator
MCW9k40GSG	9kHz-40GHz Single Channel Signal Generator
MCWG9k20GD40	9kHz-20GHz&9kHz-40GHz Dual Channel Signal Generator
MCW9k20GD20	9kHz-20GHz&9kHz-20GHz Dual Channel Signal Generator
MCW9k40GD40	9kHz-40GHz &9kHz-40GHzDual Channel Signal Generator

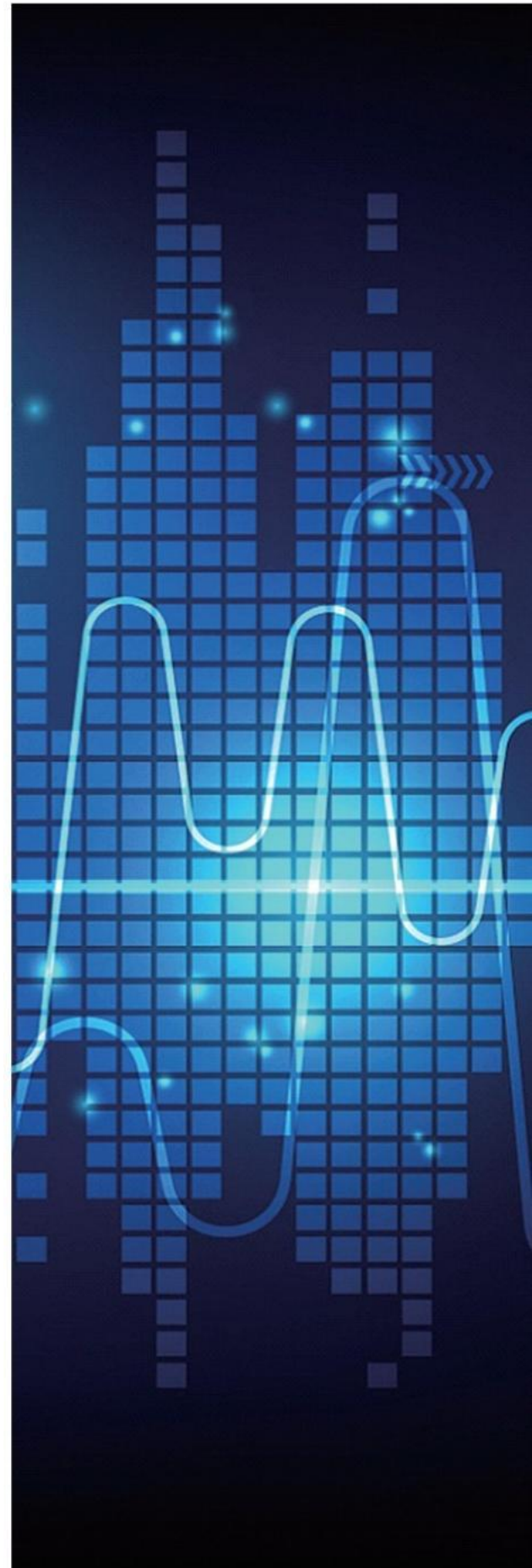

About us

Chengdu Microwave delivers one-stop RF solutions for our clients.

Our vision: Passion for the most advanced RF technologies, delivering the most satisfying RF solutions.

With over 15 years of experience, we excel in production speed, quality assurance, and cost control. We specialize in providing comprehensive RF solutions, leveraging cutting-edge signal generators to meet customer requirements with reliability and cost-effectiveness. With 25 invention patents and certifications including GJB9001C-2017 and Chengdu High-Tech Enterprise, we uphold the highest standards of quality and innovation.

Chengdu Microwave |One-stop RF & Microwave Solution



3-Year Warranty

Chengdu Microwave provides 3-Year Warranty Service for MCW9k20GSG series products. Assist our clients on boosting test confidence, reducing cost and enhancing operating convenience.

Contact us

Chengdu Microwave Technology Co.,Ltd

Address: 1st Floor, Building 3#, Huidu Science Park, No. 5 Xixin Avenue, High-tech West District, Chengdu City, China 611731

Website: www.cdmicrowave.com

E-mail: sales1@cdmicrowave.com

Tel: 0086(28)87872669*0

Fax: 0086(28)87882925

Mobile(WhatsApp): 0086-181 8078 9271